

3.2



**TUBE CUTTERS / 管割器 (金属管、塑料管)**



**Gold Medal**, International Inventors Competition, Paris 2004  
法国巴黎雷平国际发明展 金奖 2004

**1. Precision machining provides the quickest and smoothest action.**  
精密的机械加工技术，使管割器能高速、平稳地旋转操作。

**2. Extremely robust, compact and easy to use.**  
坚固牢靠、简洁紧凑的设计，令操作更加轻松舒适。

**3. Laser marked graduated scale to facilitate working action.**  
激光刻度，便于切割定位。

**4. Extra cutting wheel at the knob.**  
底部按钮内，配备有额外的切割轮。

**5. Able to cut copper, inox and plastic pipes with the proper cutting wheels.**  
装配合适的切割轮可切断铜管、不锈钢管和塑料管。

**6. Extractable reamer can work assembled in the tubing cutter or independently.**  
备用的修边器，既可以取出来独立使用，又可以半抽出配合管割器使用。

**7. Patented**  
奥戈工具技术专利



# 3.2 TUBE CUTTERS / 坡口机、管割刀 (金属管、塑料管)



## COPPER TUBE CUTTER / 铜管 管割刀

### MINI / 袖珍型

订货号 COD	材料 MAT.	最大管径 O.D.	重量(克)			切割轮	
3130100	铜	16	90	20	1	3130800	20
3130101		22	120				



### MINI 30 / 袖珍型

COD	MAT.	O.D.	gr.			切割轮	
3130102	铜	30	210	10	1	3130802	20



### CLASSIC 32 / 标准型

COD	MAT.	O.D.	gr.			切割轮	
3130103	铜	32	300	1	1	3130801	20



### TELESCOPIC 32 / 螺杆伸缩式

COD	MAT.	O.D.	gr.			切割轮	
3130104	CU	32	290	1	1	3130801	20



UNIQUE / 王牌管割器 **Gold Medal**, International Inventors Competition, Paris 2004  
法国巴黎雷平国际发明展 金奖 2004

COD	MAT.	O.D.	gr.			切割轮	
3130105	铜	35	480	1	1	3130803	10
3130106		42	550	8			
3130107		45	600	1			



### AUTOMATIC 50 / 自动伸缩

COD	MAT.	O.D.	gr.			切割轮	
3130108	CU	50	450	1	1	3130804	10



### AUTOMATIC 67 / 棘轮式可伸缩

COD	MAT.	O.D.	gr.			切割轮	
3130109	铜管	67	750	1	1	3130803	10



### AUTOMATIC 127 / 自动伸缩

COD	MAT.	O.D.	gr.			切割轮	
3130110	铜管	50-127	1950	1	1	3130805	10



## KIT 3 铜管 管割器组套 (3件套)

COD	
3130111	3130101 - 3130103 - 3130106



## ROLLCUT 自调式

订货号 COD	材料 MAT.	最大管径 O.D.	重量(克)			切割轮	
3130120	铜管	12	230	6	1	3130820	10
3130121		15	220				
3130122		18	250				
3130123		22	240				

自夹紧和自对齐, 防止管变形。防滑表面, 可靠抓牢。侧面有转动指示方向, 只需转动几圈便能快速切割管子。符合人体工程学, 更小的操作空间, 在难以触及的地方应用的理想工具 (例如: 可以在防墙很近的地方切割。)



## 3.2 TUBE CUTTERS / 坡口机、管割刀 (金属管、塑料管)

INOX TUBE CUTTER / 不锈钢管 管割刀 可切断最大壁厚: 2mm

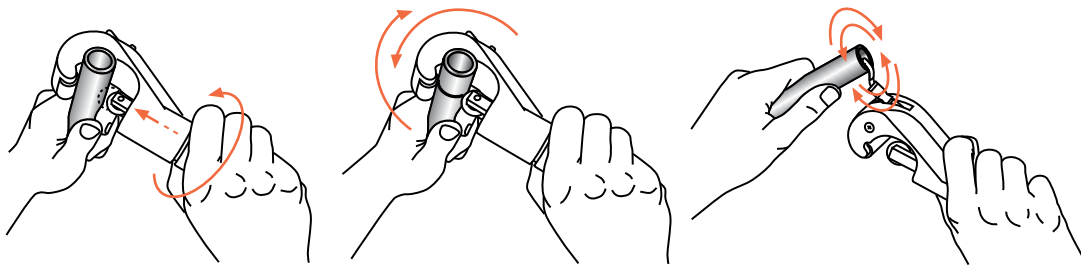

### MINI / 袖珍

订货号 COD	材料 MAT.	最大管径 O.D.	重量(克)	切割轮
3130200	INOX	16	90	3130830 3130831
3130201		22	120	



### MINI 30 / 袖珍

COD	MAT.	O.D.	gr.	切割轮
3130202	INOX	30	210	3130832



### CLASSIC 32 / 标准型

COD	MAT.	O.D.	gr.	切割轮
3130203	INOX	32	300	3130831



### TELESCOPIC 32 / 螺杆伸缩式

COD	MAT.	O.D.	gr.	切割轮
3130204	INOX	32	290	3130831



### UNIQUE / 王牌管割器 Gold Medal, International Inventors Competition, Paris 2004 法国巴黎雷平国际发明展 金奖 2004

COD	MAT.	O.D.	gr.	切割轮
3130205	INOX	35	480	3130833
3130206		42	550	
3130207		45	600	



### AUTOMATIC 50 / 自动伸缩

COD	MAT.	O.D.	gr.	切割轮
3130208	INOX	50	450	3130834



### AUTOMATIC 67 / 棘轮式自动伸缩

订货号 COD	材料 MAT.	最大管径 O.D.	重量(克)	切割轮
3130209	INOX	67	750	3130833



### KIT 3 / 不锈钢管 管割器组套 (3件套)

COD	包含的零件
3130210	3130201 - 3130203 - 3130206



## 3.2 TUBE CUTTERS / 坡口机、管割刀 (金属管、塑料管)

### STEEL & INOX PIPE CUTTER / 钢管、不锈钢管 管割刀

#### STEEL / 钢管

COD 订货号	管径	最大壁厚	Kg. 重量	包装	切割轮
3156001	1/8"- 1.1/4"	4,8mm	1,1	1	3156100
3156002	1/8"- 2"	5,6mm	2,5		3156101

#### INOX / 不锈钢管

COD	管径	最大壁厚	Kg. 重量	包装	切割轮
3156011	1/8"- 1.1/4"	4,8mm	1,1	1	3156102
3156012	1/8"- 2"	5,6mm	2,5		3156103

#### STEEL / 钢管

COD	管径	最大壁厚	Kg. 重量	包装	切割轮
3156021	1/8"- 2"	5,6mm	3,2	1	3156101
3156022	1"- 3"	7,6mm	5,0		3156104

#### INOX / 不锈钢管

COD	管径	最大壁厚	Kg. 重量	包装	切割轮
3156031	1/8"- 2"	5,6mm	3,2	1	3156103
3156032	1"- 3"	7,6mm	5,0		3156105

#### STEEL / 钢管 (加强型)

COD	管径	最大壁厚	Kg. 重量	包装	切割轮
3156043	2"- 4"	8,6mm	8,0	1	3156106

#### INOX / 不锈钢管 (加强型)

COD	管径	最大壁厚	Kg. 重量	包装	切割轮
3156053	2"- 4"	8,6mm	8,0	1	3156107



德国风格



美国风格



加强型4寸管割刀

### HINGED PIPE CUTTER / 铰接式 管割钳

#### STEEL / 钢管

COD	管径	最大壁厚	Kg. 重量	包装	切割轮
3156063	2"- 4"	8,6mm	6,0	1	3156108
3156064	4"- 6"	8,6mm	9,0		3156109
3156065	6"- 8"	8,6mm	11		3156110
3156066	8"- 12"	8,6mm	16		3156111

#### INOX / 不锈钢管

COD	管径	最大壁厚	Kg. 重量	包装	切割轮
3156073	2"- 4"	8,6mm	6,0	1	3156112
3156074	4"- 6"	8,6mm	9,0		3156113
3156075	6"- 8"	8,6mm	11		3156114
3156076	8"- 12"	8,6mm	16		3156115

#### CAST AND DUCTILE IRON / 铸造韧钢管

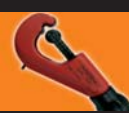
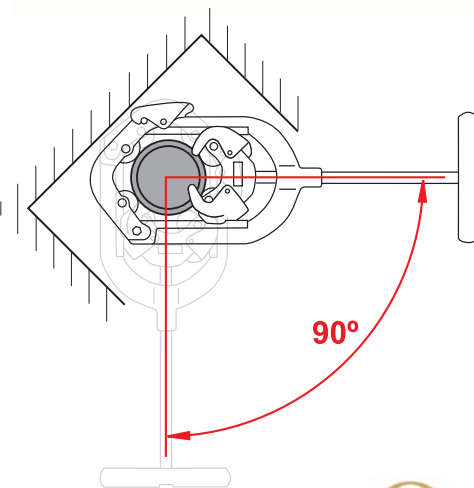

COD 订货号	管径	最大壁厚	Kg. 重量	包装	切割轮
3156083	2"- 4"	8,6mm	6,0	1	3156116
3156084	4"- 6"	8,6mm	9,0		3156117
3156085	6"- 8"	8,6mm	11		
3156086	8"- 12"	8,6mm	16		

铰接式管割钳，专门为现场作业设计，无需360°旋转割刀，用户只需左右摆动割刀，便可轻松切断管道。例如，针对工地上卧躺在地面的管道切割。使用时，垂直于管道打开钳口，钳把“抱住”管道，做90°的左右摆动，4个强大的切割轮会迅速地切断管道。典型用户：埃克森美孚。





## 3.2 TUBE CUTTERS / 坡口机、管割刀 (金属管、塑料管)

### ELECTRIC BANDSAW / 电动带锯 MULTIFUNCTION / 多功能电动带锯

COD	管径 CAP	截面积 CAP	功率 W	电压 V		Kg.
3170154	115	120x115	320	230	1356x13x0,65	21
COD						
					3178141	1356x13x0,65 - 14
					3178142	1356x13x0,65 - 18

### PORTABLE HEAD / 便携式 (即: 多功能电动带锯 拆去底座)

COD	CAP	CAP	W	V		Kg.
3170155	115	120x115	320	230	1356x13x0,65	21
COD						
					3178141	1356x13x0,65 - 14
					3178142	1356x13x0,65 - 18

### RECIPROCATING SAW / 往复式电锯

COD	管径 CAP	功率 W	转数/分钟 R.P.M.	电压 V		Kg.
	metal / wood 金属 木材					
3170156	90/115	750	2500	230	152x0,9 - 25,5	5,0
COD						
					3178143 (metal) 金属	152x0,9 - 25,5
					3178144 (wood) 木材	152x1,2 - 10,5

### ELECTRIC PIPE CUTTING & BEVELLING MACHINE / 电动管道切割与坡口机

订货号 COD	通径 Ø	外径 O.D.	电压 V	壁厚 mm	转速 R.P.M.	重量 Kg.
3132015	3/8"-2.1/2"	Ø10-80 mm	230V(50-60Hz)	≤ 25mm	20	24
3132024			110V(50-60Hz)			
3132016	2.1/2"-5"	Ø65-150 mm	230V(50-60Hz)		16	32
3132025			110V(50-60Hz)			
3132017	6"-10"	Ø150-300 mm	230V(50-60Hz)		13	65
3132026			110V(50-60Hz)			
3132018	12"-16"	Ø300-450 mm	230V(50-60Hz)		10	90
3132027			110V(50-60Hz)			
3132019	18"-22"	Ø450-600 mm	230V(50-60Hz)		8	126
3132028			110V(50-60Hz)			
3132020	24"-28"	Ø600-750 mm	230V(50-60Hz)		7	209
3132029			110V(50-60Hz)			
3132021	30"-34"	Ø750-900 mm	230V(50-60Hz)		6	321
3132030			110V(50-60Hz)			
3132022	36"-40"	Ø900-1050 mm	230V(50-60Hz)	5	468	
3132031			110V(50-60Hz)			
3132023	46"-50"	Ø1150-1300 mm	230V(50-60Hz)	5	1186	
3132032			110V(50-60Hz)			

Current / 电流 6A Power / 功率 0,5-2,5KW

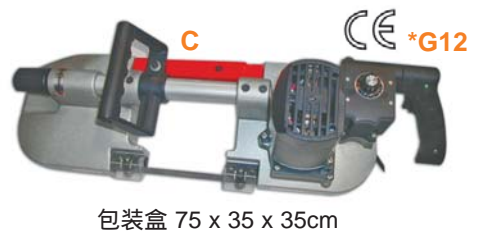

每套设备配2把不同的坡口刀: 30度角、37.5度角。  
管道另一端需适当固定, 以支持设备正常作业。



# 3.2 TUBE CUTTERS / 坡口机、管割刀 (金属管、塑料管)



WITH SERVOMOTOR / 电动坡口机 (带伺服电动机)

**NEW**  
CE \*G12



COD	Ø	O.D.	V	Ø	R.P.M 1	R.P.M 2	Kg.
3132036	24"-28"	600-750mm	230 (50-60hZ)	≤25mm	0-10	0-16.2	220
3132037	30"-34"	750-900mm			0-8.5	0-14	265
3132038	36"-40"	900-1050mm			0-7.5	0-12	310
3132039	46"-50"	1150-1300mm			0-7	0-11.5	385

Current / 电流 6A Power / 功率 2,3KW

## POWER PIPE CUTTER / 电动切管机

KIT CORTAMATIC - 12  
SET INCLUDING MASTERMATIC-2 / 组套, 包括套丝机 MASTERMATIC-2

COD	V	CAP	Kg.
3170160	230	2.1/2-12"	75



CORTAMATIC - 12  
组套, 不含套丝机 MASTERMATIC-2

COD	CAP	Kg.
3170162	2.1/2-12"	65



### Technical specification / 技术规格

- Powerful 10-ton hydraulic cylinder / 强大的10吨液压缸
- Perfect square cuts, without dust or sparks / 完美的切割、无火花、无灰尘
- 2 pipe stands included / 包含2个水管支架



### PIPE CUTTING CAPACITY (THICKNESS MM) / 切管能力 (厚度: 毫米)

	2.1/2"	3"	4"	5"	6"	8"	10"	12"
SCHEDULE 10	3,05	3,05	3	3,4	3,4	4,78	4,19	4,57
SCHEDULE 40	5,16	5,49	6,02	6,55	7,11	8,18	-	-
DIN 2440	3,65	4,05	4,5	4,85	4,85	-	-	-

### SPARE PARTS / 配件

		
3170163	3170167	3170168

### REAMERS / 修边器 (去毛刺器)

去毛刺器 (通用刀片)

COD		gr.				
3130300	Cu / STEEL / PLASTIC / INOX 铜 / 钢 / 塑料 / 不锈钢	90	20	1	3130840	3130841

应用于: 边界、管子和金属板的去毛刺工作。



去毛刺器 (通用刀片, 金属壳)

COD		gr.				
3130302	Cu / STEEL / PLASTIC / INOX 铜 / 钢 / 塑料 / 不锈钢	50	20	1	3130840	-



金属壳



## 3.2 TUBE CUTTERS / 坡口机、管割刀 (金属管、塑料管)

### 小型去毛刺器



3130306	Cu / STEEL / PLASTIC / INOX 铜 / 钢 / 塑料 / 不锈钢	10	20	1	3130840	-
---------	---	----	----	---	---------	---



### 管口倒角器 (管口内外去毛刺器)



3130325	Cu / STEEL / PLASTIC / INOX 铜 / 钢 / 塑料 / 不锈钢	8-35mm / 5/16"-1.3/8"	250	1	1
3130326	BRASS / ALUMINIUM 黄铜 / 铝	10-54mm / 1/2"-2.1/8"	500		



### CHAMFERBIT / 管铰刀



3130309	Cu / STEEL / PLASTIC / INOX 铜 / 钢 / 塑料 / 不锈钢	12,4	3	100	6
3130310		25		120	



Material: 材料HSS (M2)

### CONIC MILLING TOOL / 铣铰刀



3130311	Cu / STEEL / PLASTIC / INOX 铜 / 钢 / 塑料 / 不锈钢	10-34	6	150	6
---------	---	-------	---	-----	---



Material: 材料HSS

### TAPER REAMER / 锥铰刀



3130312	Cu / STEEL / PLASTIC / INOX 铜 / 钢 / 塑料 / 不锈钢	3-12	6	100	6
3130313		10-25	8	120	



Material: 材料HSS

### SCRAPPER / 去毛刺刀



3130314	铜 / 钢 / 塑料 / 不锈钢 CU / STEEL / PLASTIC / INOX	60	20	1	3130844
---------	---	----	----	---	---------



3130840	Cu / STEEL / PLASTIC / INOX 铜 / 钢 / 塑料 / 不锈钢	47	6
3130842	BRASS / CAST IRON 黄铜 / 生铁		
3130841	Cu / STEEL / PLASTIC / INOX 铜 / 钢 / 塑料 / 不锈钢	26	20
3130843	BRASS / CAST IRON 黄铜 / 生铁		
3130844	Cu / STEEL / PLASTIC / INOX 铜 / 钢 / 塑料 / 不锈钢	120	20



### COPPER CLEANING BRUSHES / 铜清洁刷



3130320	1/2"-3/4"	INT.内 / EXT.外	30	6	1
3130321	1/2"	INT.内 / EXT.外	10	6	1
3130322	1/2"	INT.外	5	6	1





# 3.2 TUBE CUTTERS / 坡口机、管割刀 (金属管、塑料管)



## PLASTIC PIPE CUTTER / 塑料管棘轮切刀

棘轮连接，刀片可更换。应用于切割：塑料管、压力管和加热管等，具体每个型号下面有塑料管类型的说明。

PIRAINA®

COD	O.D.	gr.			
3140200*	42	550	6	1	3140800
3140201*					3140801



\*3140200: KEVLAR, PVC, PE, PP, PB, VPE, PVDF, MLP, HTA, PPR, PEX, 多层管  
\*3140201: PVC, PE, PP, PB, VPE, PVDF, MLP, HTA, PPR, PEX, 多层管



Ø 42 Ø 42 15x30 Ø 12



Silver Medal, International Inventors Competition, Paris 2004  
法国巴黎雷平国际发明展 大奖 2004



Precise geometry  
精确的几何切角



KEVLAR  
快速切断凯夫拉尔纤维管



Rigid PVC  
轻松切断聚氯乙烯硬管

COD	O.D.	gr.			
3140202*	51	475	6	1	3140802
3140203*	64	550			3140803



\*3140202 \*3140203: PE, PP, PB, VPE, PVDF, MLP, HTA, PPR, PEX, MULTILAYER 多层管



PVC / 管割刀	O.D.	gr.			
3140204*	35	175	6	1	3140804



\*3140204: PB, PEX, MULTILAYER 多层管



## STANDARD / 通用型塑料管割刀

	O.D.	gr.			
3140205*	42	300	6	1	3140805



\*3140205: PE, PP, PB, VPE, PVDF, MLP, PPR, PEX, MULTILAYER 多层管



COD	O.D.	gr.			
3140206*	63	1200	1	1	3140806



\*3140206: PE, PP, PB, VPE, PVDF, MLP, PPR, PEX, MULTILAYER 多层管



## AUTOMATIC PLASTIC PIPE CUTTER / 枪式塑料管棘轮切刀

棘轮连接，刀片可更换，按下按钮可使刀片快速复位。应用于切割：塑料管、压力管和加热管等，具体每个型号下面有管子说明。

COD	O.D.	gr.			
3140207*	35	550	1	1	3140807



\*3140207: KEVLAR, PVC, PE, PP, PB, VPE, PVDF, MLP, HTA, PPR, PEX, MULTILAYER 多层管



COD	O.D.	gr.			
3140208*	42	700	1	1	3140808



\*3140208: KEVLAR, PVC, PE, PP, PB, VPE, PVDF, MLP, HTA, PPR, PEX, MULTILAYER 多层管



## 3.2 TUBE CUTTERS / 坡口机、管割刀 (金属管、塑料管)

### UNIQUE / 王牌管割刀

COD	MAT.	 O.D.	 gr.				
3140209	PLASTIC 塑料管	35	500	1	1	3140809	10
3140210		42	550	8			
3140211		45	600	1			



### AUTOMATIC 50 / 自动管割刀

COD	MAT.	 O.D.	 gr.				
3140212	PLASTIC 塑料管	50	450	1	1	3140810	10



### AUTOMATIC 67 / 自动管割刀

COD	MAT.	 O.D.	 gr.				
3140213	PLASTIC 塑料管	67	750	1	1	3140813	10











### AUTOMATIC 127 / 自动管割刀

COD	MAT.	 O.D.	 gr.				
3140214	PLASTIC 塑料管	50-125	1950	1	1	3140811	10



### SIERRA PARA PVC/ABS / ABS切锯

COD	 L	 A	 B	 /inch	 gr.	
3140300	395	64 mm	12" (300)	18	300	6
3140830						
3140831						

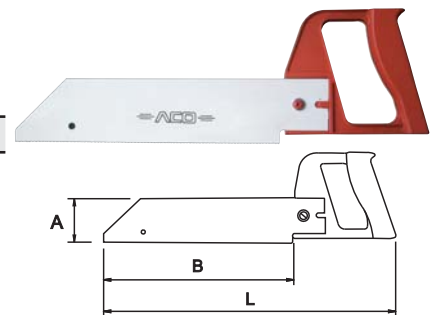

### ELECTRIC PIPE CUTTER / 电动塑料管割刀

COD	 mm		<b>W</b>	<b>V</b>	 Kg.			
3140220	42	≤6,7 mm	70	9,6	1,2	1	3140812	





 PP, PVC, PPR, PEX, KEVLAR, MULTILAYER

#### Technical specification / 技术规格

Charger / 充电器	NiMH 镍氢电池 100-240V, 50-60Hz, 6W
Charging time / 充电时间	2h / 2小时
Cutting capacity / 每充切割次数	200 cuts / 200次
Cutting speed / 切割速度	4s / 4秒
Dimensions / 尺寸	225*180*103mm毫米



### EXTERNAL REAMER FOR PLASTIC PIPE / 塑料管外部去毛刺器

COD	 mm	 Kg.		
3140600	25-160	0,8	1	3140960
3140601	40-315	1,4		3140961

